

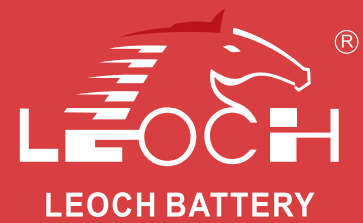

LHR Series-High Rate

LHR12700W(A)(12V700W)



Specifications

Rated Voltage	12V		
Nominal Rate($W_{15}, 1.67V/cell$)	700W/cell		
Nominal Capacity($C_{10}, 1.80V/cell$)	180Ah		
Dimension	Length	532±2mm (20.9 inches)	
	Width	207±2mm (8.14 inches)	
	Container Height	214±2mm (8.42 inches)	
	Total Height	220±2mm (8.66 inches)	
Approx Weight	59.5kg (131.2 lbs)		
Terminal	M8		
Container Material	ABS: UL 94 HB or V-0 optional		
Rated Capacity(25°C)	180.0 Ah	C10(18.0A, 1.80V/cell)	
	167.2 Ah	C8(20.9A, 1.80V/cell)	
	158.5 Ah	C5(31.7A, 1.75V/cell)	
	140.4 Ah	C3(46.8A, 1.75V/cell)	
	114.6 Ah	C1(114.6A, 1.60V/cell)	
Max. Discharge Current	1800A (5s)		
Internal Resistance(25°C)	Approx 3.0mΩ		
Operating Temp. Range	Discharge	-20 ~ 55°C (-4 ~ 131°F)	
	Charge	-20 ~ 40°C (-4 ~ 104°F)	
	Storage	-15 ~ 50°C (5 ~ 122°F)	
Nominal Operating Temp. Range	25±3°C (77±5°F)		
Max.Charging Current(25°C)	45.0A		
Charge voltage(25°C)	Float	2.25 ~ 2.30V/cell	-3mV/cell/°C
	Equalization	2.30~2.40V/cell	-4mV/cell/°C
Effect of temp. to Capacity	40°C (104°F)	106%	
	25°C (77°F)	100%	
	0°C (32°F)	86%	
Self Discharge	≤3%/month @ 25°C		



Layout

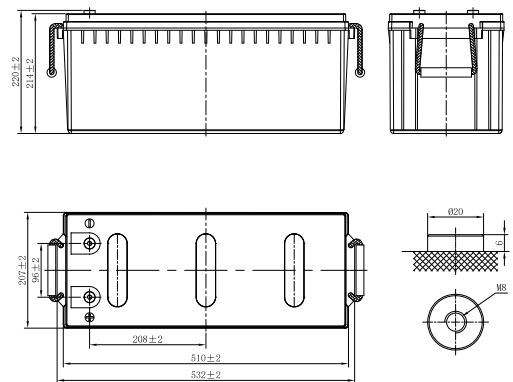

Constant Current Discharge (Amperes) at 25 °C (77°F)

F.V/Time	5min	10min	15min	20min	30min	45min	1h	1.5h	2h	3h	4h	5h	8h	10h
1.85V/cell	418.7	334.3	289.8	227.9	157.9	122.2	99.1	72.7	59.5	44.3	35.0	29.6	20.5	17.5
1.80V/cell	476.2	379.5	328.5	257.7	178.1	129.8	102.4	74.9	63.0	45.8	36.3	30.8	20.9	18.0
1.75V/cell	517.8	412.0	356.0	278.5	191.8	137.6	106.6	78.0	65.4	46.8	37.5	31.7	21.1	18.1
1.70V/cell	553.0	438.8	377.7	295.0	203.1	145.4	111.3	81.3	67.0	47.8	38.4	32.4	21.4	18.2
1.67V/cell	572.3	452.7	388.7	303.0	207.9	148.6	112.5	83.4	68.6	48.8	38.9	32.8	21.7	18.5
1.60V/cell	592.5	468.2	400.7	310.8	213.0	152.5	114.6	86.2	69.9	50.1	39.8	33.5	21.8	18.6

Constant Power Discharge (Watts/cell) at 25 °C (77°F)

F.V/Time	5min	10min	15min	20min	30min	45min	1h	1.5h	2h	3h	4h	5h	8h	10h
1.85V/cell	782.0	628.9	548.8	433.6	301.8	235.0	191.6	141.0	115.7	86.6	68.7	58.4	40.7	34.8
1.80V/cell	874.8	703.5	613.9	485.0	337.6	247.9	197.0	144.5	121.9	89.0	71.0	60.4	41.4	35.7
1.75V/cell	934.7	751.7	655.9	518.2	360.7	261.3	204.2	149.8	126.1	90.7	73.1	61.9	41.7	35.9
1.70V/cell	981.5	789.4	688.8	544.2	378.8	274.1	212.0	155.3	128.6	92.4	74.6	63.2	42.3	36.1
1.67V/cell	997.5	802.2	700.0	553.0	385.0	278.7	213.1	158.6	131.1	93.9	75.3	63.8	42.6	36.6
1.60V/cell	1011.5	813.4	709.8	560.7	390.4	283.3	215.5	162.8	132.8	95.8	76.7	64.8	42.8	36.7

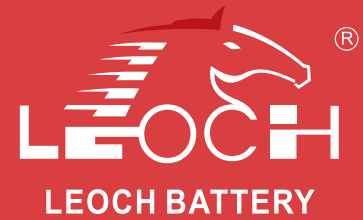

LHR Series-High Rate

LHR12700W(A)(12V700W)

Applications

- UPS
- Hospitals & Testing Laboratories
- Emergency Power Supply
- Banks & Financial Markets
- Industrial Process Control Facilities
- Data & Network Operation Centers

General Features

- High quality AGM separator: extend cycle life and prevent micro short circuit
- PbCaSn alloy for plate grids: less gassing, less self-discharging
- Unique vent valve design: reduce water losing and prevent air/spark going inside

Standards

- Compliance with IEC 60896 and YD/T 3427 standards
- Manufactured in Leoch@IATF16949, ISO 45001, ISO 9001 and ISO 14001 certified production facilities

Discharge Characteristics

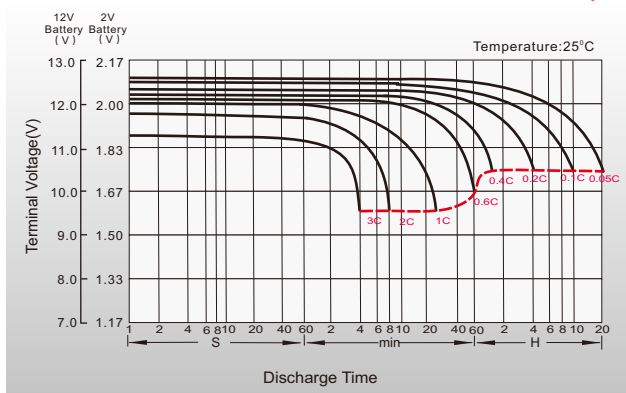

Float Charging Characteristics

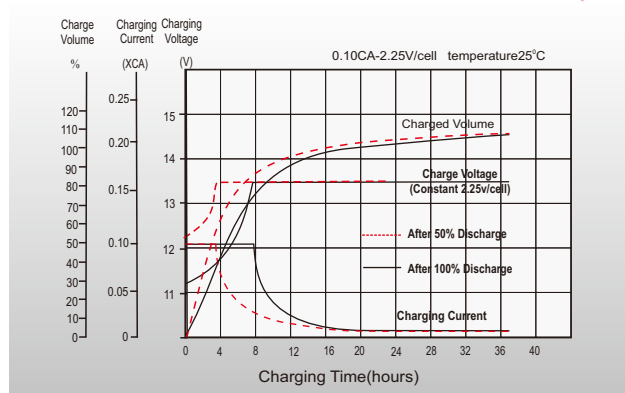

Temperature Effects in Relation to Battery Capacity

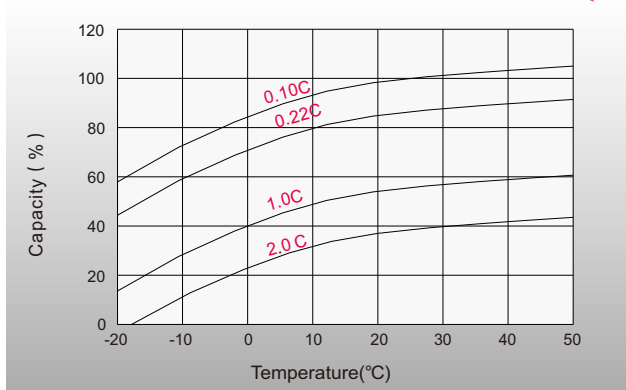

Temperature Effects on Long Term Float Life

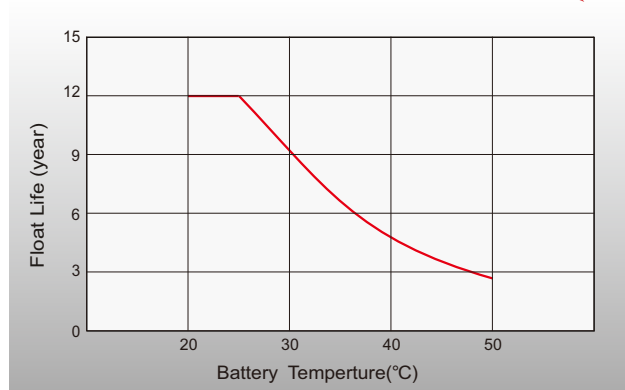

Sales Offices Worldwide

China Sales Office

5th Floor, Xinbaohui Bldg., Nanhai Blvd.,
Nanshan, Shenzhen, China. 518052
Tel: +86-755-86036060 (100 lines)
Fax: +86-755-26067269
E-mail: export@leoch.com

HongKong Sales Office

Workshop C, 33/F, TML Tower, No. 3 Hoi Shing Road,
Tsuen Wan, New Territories, Hong Kong
Tel: +852 35786666
Fax: +44 1452 690125
E-mail: sales.hk@leoch.com

Singapore Sales Office

No. 1 Tech Park Crescent,
Singapore 638131
Tel: +65 68636078
Fax: +65 6863 6079
Email: sales.sg@Leoch.com

Australia Sales Office

2/29 Tarlington Place, Smithfield. NSW 2164
Australia
Tel: 02 9756 0950
E-mail: sales.au@leoch.com

North America Sales Office

19751 Descartes
Foothill Ranch, CA 92610, USA
Tel: 949-588-5853
Fax: 949-588-5966
E-mail: sales@leoch.us
Http://www.leoch.us

UK Sales Office

9B Wheatstone Court, Waterwells, Business Park,
Gloucester, GL2-2AQ, UK United Kingdom
Tel: +44(0) 1452 729428 / 1452 729696
Fax: +44 1452 690125
E-mail: Sales.Europe@leoch.com
Http://www.leoch.eu

EMEA Sales Office

1 Deligiorgi St., 121 31 Athens,
Greece
Tel: +30 210 5760318 (2 lines)
E-mail: support_EMEA@leoch.com
Http://www.leoch.eu

India Sales Office

Shed no. A-53(b), 2nd Stage of Peenya Industrial Area,
Bangalore North Taluk, Bangalore-560058, India
Tel: +91-80-23440018/23440019
Fax: +91-80-23440017
E-mail: indiasales@leoch.com



[Http://www.leoch.com](http://www.leoch.com)

© 1999-2022 LEOCH. All rights reserved.

Trademarks and logos are the property of LEOCH and its affiliates unless otherwise noted.
Subject to revisions without prior notice.

Publication No.: LB-LHR12700W(A)-PD-EN-V1.0-202201